



LAL+ short



LA+



LAL+

PRODUCT DATA SHEET

DROP IN ANCHORS

FOR REDUNDANT NON-STRUCTURAL APPLICATIONS



ETA-approved drop in anchors ideal for suspension systems

Internal thread for metric bolts and rods

Internal thread for
metric bolts and rods

Zinc plated

Drop in anchor
with ETA approval

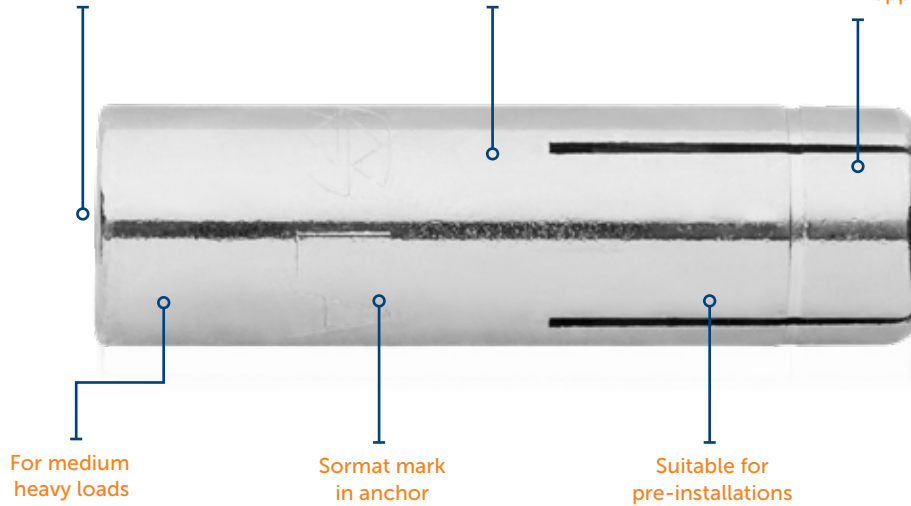

For medium
heavy loads

Sormat mark
in anchor

Suitable for
pre-installations

DROP IN ANCHORS LA+ AND LAL+

Description

- For multiple use for non-structural applications in cracked and non-cracked concrete, hollow core slab
- Displacement controlled expansion anchor
- Drop in anchors for pre-installation with an installation tool
- Internal thread for metric bolts and rods
- Suitable bolt length is 1-1,5 x the nominal size of the anchor + fixture thickness.
- ZP for dry indoor and temporary outdoor use.
- Fixing screws or anchor rods
 - Steel grades categories 4.6, 5.6, 5.8 or 8.8 acc. EN ISO 898-1



LA+

Drop in anchor without a collar

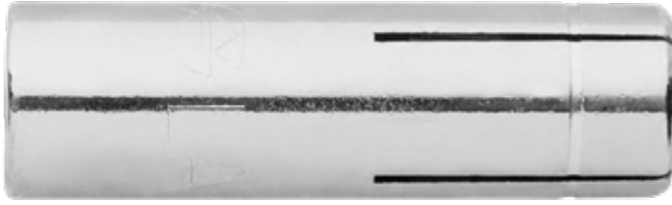

LAL+

Drop in anchor with a collar



LAL+ short

Short drop in anchor with a collar



Base materials

Approved for



Cracked
concrete



Non-cracked
concrete



Hollow
core slab

Also suitable for









Solid
clay brick



Natural
stone

APPROVALS / CERTIFICATIONS / APPLICATIONS

Description of document		Authority/ Laboratory	ID	Additional info
European Technical Assessment		Deutsches Institut für Bautechnik	ETA-13/0441	EAD 330747-00-0601, M6, M8 and M10 for redundant non-structural applications
Fire resistance		Deutsches Institut für Bautechnik	ETA-13/0441	EAD 330747-00-0601
Sormat Trustfix anchor calculation software		Sormat Oy / S&P Software Consulting		TrustFIX anchor calculation
CAD-blocks for AutoCAD		Sormat Oy		Blocks installation instructions for AutoCAD
Drop in anchor components for TEKLA Structures		Sormat Oy		Tekla structures components + instructions video
YouTube installation videos		Sormat Oy		Sormat LA+ drop in anchor presentation video

LA+, LAL+ DROP IN ANCHORS

STATIC AND QUASI-STATIC LOADS FOR REDUNDANT NON-STRUCTURAL APPLICATIONS

The data of these tables is based on:

- ETA-13/0441
- Anchors for redundant non-structural applications
- Concrete C20/25, $f_{ck,cube} = 25 \text{ N/mm}^2$
- Installation has been done correctly (see page 8)
- Edge- and spacing distance's (see page 11)
- Respect of minimum base material thickness (see page 11)
- Load values are based on screw or rod with steel grade ≥ 4.6
- Zinc plated anchors (LA+/LAL+)

Characteristic resistances, all load directions

Anchor size		M6	M8x25	M8	M10x25	M10
Approval		ETA-13/0441	ETA-13/0441	ETA-13/0441	ETA-13/0441	ETA-13/0441
Effective anchorage depth h_{ef}	[mm]	25	25	30	25	40
Concrete						
Load F_{Rk}	[kN]	1,5	2,5	3,0	2,5	7,5

Design resistances, all load directions

Anchor size		M6	M8x25	M8	M10x25	M10
Approval		ETA-13/0441	ETA-13/0441	ETA-13/0441	ETA-13/0441	ETA-13/0441
Effective anchorage depth h_{ef}	[mm]	25	25	30	25	40
Concrete						
Load F_{Rd}	[kN]	0,7	1,4	1,7	1,4	4,2

Recommended loads, all load directions

Anchor size		M6	M8x25	M8	M10x25	M10
Approval		ETA-13/0441	ETA-13/0441	ETA-13/0441	ETA-13/0441	ETA-13/0441
Effective anchorage depth h_{ef}	[mm]	25	25	30	25	40
Concrete						
Load F_{Rec}	[kN]	0,5	1,0	1,2	1,0	3,0

The partial safety factor for action is $\gamma = 1.4$.

Requirements for multiple anchoring

The definition of member states are included in an annex to the ETAG 001 Part 6, Annex 1

Minimum number of fixing points	Minimum number of anchors per fixing point	Maximum design load of action N_{sd} per fixing point
3	1	2 kN
4	1	3 kN

The value N_{sd} might be increased if in the design it is shown that the requirements on the strength and stiffness of the fixture in the serviceability and ultimate states after the failure of one anchor are fulfilled.

BASIC LOADING DATA FOR PRECAST PRE-STRESSED HOLLOW CORE SLABS

The data of these tables is based on:

- ETA-13/0441
- Precast pre-stressed hollow core slabs with flange thickness ≥ 35 mm and concrete C45/55 to C50/60
- Installation has been done correctly (page 8).
- Edge distances and spacings acc. page 11.
- Respect of minimum base material thickness (p. 11)
- Load values are based on screw or rod with steel grade ≥ 4.6
- Zinc plated anchors (LA+/LAL+)

Characteristic resistances

Anchor size			M8x25	M10x25
Nominal anchorage depth	h_{nom}	[mm]	25	
Flange thickness	d_b	[mm]	35	
Load for all directions	F_{Rk}	[kN]	3,0	4,0

Design resistances

Anchor size			M8x25	M10x25
Nominal anchorage depth	h_{nom}	[mm]	25	
Flange thickness	d_b	[mm]	35	
Load for all directions	F_{Rd}	[kN]	1,7	2,2

Recommended loads

Anchor size			M8x25	M10x25
Nominal anchorage depth	h_{nom}	[mm]	25	
Flange thickness	d_b	[mm]	35	
Load for all directions	F_{rec}	[kN]	1,2	1,6

The partial safety factor for action is $\gamma = 1.4$.

Requirements for multiple anchoring

The definition of multiple use according to the Member States is given in annex of the ETAG 001 Part 6.

Minimum number of fixing points	Minimum number of anchors per fixing point	Maximum design load of action N_{sd}
3	1	2 kN
4	1	3 kN

The value N_{sd} might be increased if in the design it is shown that the requirements on the strength and stiffness of the fixture in the serviceability and ultimate states after the failure of one anchor are fulfilled.

FIRE RESISTANCE UNDER FIRE EXPOSURE IN ANY LOAD DIRECTION

The data of these tables is based on: **ETA-13/0441**

- Anchors for redundant non-structural applications
- Concrete C20/25, $f_{ck,cube} = 25 \text{ N/mm}^2$
- Installation has been done correctly (see page 8)
- Edge- and spacing distances (see page 11)
- Respect of minimum base material thickness (see page 11)
- Load values are based on screw or rod with steel grade ≥ 4.6
- Zinc plated anchors (LA+/LAL+)



Characteristic resistances, all load directions

Anchor size		M6	M8	M10
Approval		ETA-13/0441	ETA-13/0441	ETA-13/0441
Effective anchorage depth h_{ef}	[mm]	25	30	40
Fire Exposure R30				
Load $F_{Rk,fi}$	\geq Steel 4.6 [kN]	0,2	0,3	0,6
Fire Exposure R120				
Load $F_{Rk,fi}$	\geq Steel 4.6 [kN]	0,1	0,2	0,3

Design resistances, all load directions

Anchor size		M6	M8	M10
Approval		ETA-13/0441	ETA-13/0441	ETA-13/0441
Effective anchorage depth h_{ef}	[mm]	25	30	40
Fire Exposure R30				
Load $F_{Rd,fi}$	\geq Steel 4.6 [kN]	0,2	0,3	0,6
Fire Exposure R120				
Load $F_{Rd,fi}$	\geq Steel 4.6 [kN]	0,1	0,2	0,3

Recommended loads, all load directions

Anchor size		M6	M8	M10
Approval		ETA-13/0441	ETA-13/0441	ETA-13/0441
Effective anchorage depth h_{ef}	[mm]	25	30	40
Fire Exposure R30				
Load $F_{Rec,fi}$	\geq Steel 4.6 [kN]	0,2	0,3	0,6
Fire Exposure R120				
Load $F_{Rec,fi}$	\geq Steel 4.6 [kN]	0,1	0,2	0,3

Spacing and edge distance under fire exposure

Anchor spacing	$S_{cr,fi}$	[mm]	100	120	160
Edge distance	$C_{cr,fi}$	[mm]	50	60	80

In the absence of other national regulations the partial safety factor for resistance under fire exposure $\gamma_{M,fi} = 1,0$ is recommended.

MATERIALS AND DIMENSIONS

Material quality and coating

Anchor

Material	Cold formed steel
Coating	Zinc electroplated min. 5 µm

Mechanical properties

Specification			M6	M8	M10
Nominal characteristic steel yield strength		f_{uk} [N/mm ²]	485	485	485
Nominal characteristic steel ultimate strength		f_{yk} [N/mm ²]	535	535	535
Char. bending resistance	Screw 4.6	$M_{Rk,s}^0$ [Nm]	6,1	15,0	29,9
Design bending resistance	Screw 4.6	$M_{Rd,s}$ [Nm]	3,6	9,0	17,9
Recommended bending resistance	Screw 4.6	M_{rec} [Nm]	2,6	6,4	12,8

SETTING INSTRUCTIONS

Installation equipment

Specification	M6	M8	M10
Rotary hammer	750...1200 r.p.m / 1.8 ...3.3 J		
Drill bit	SDS+ 2-CUT or 4-CUT		
	Ø 8 mm	Ø 10 mm	Ø 12 mm
Additional tools	Air pump/compressor, LT+ or LT+ PRO setting tool, hammer, torque wrench		

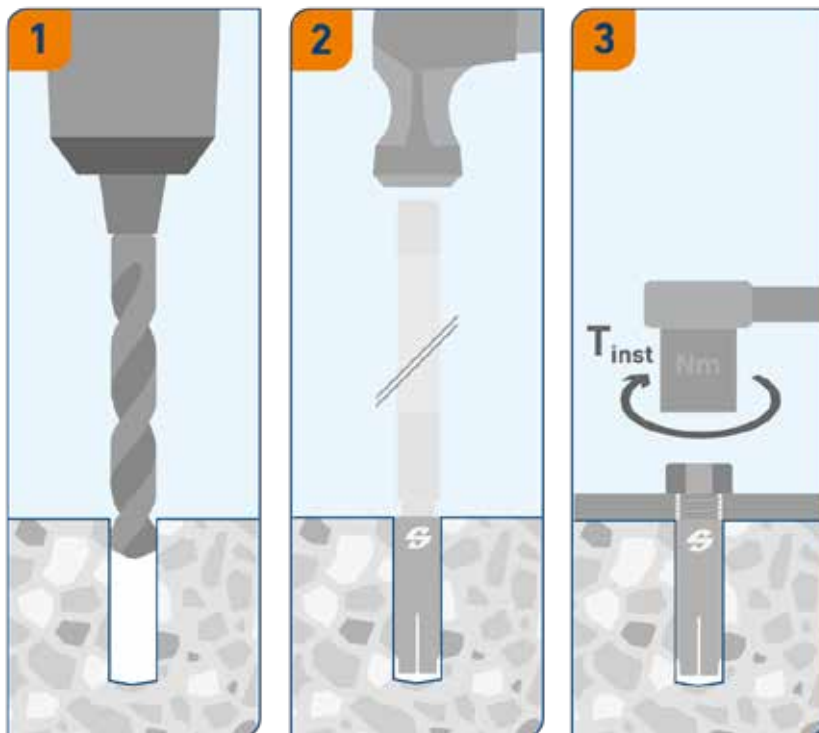

INSTALLATION

Installation data and anchor dimensions

Parameters and anchors sizes			M6 x 25	M8 x 25	M8 x 30	M10 x 25	M10 x 40
Anchor outer diameter	d	[mm]	8	10	10	12	12
Drill hole diameter	d_0	[mm]	8	10	10	12	12
Anchorage depth	h_{ef} / h_{nom}	[mm]	25	25	30	25	40
Depth of drilled hole to deepest point	$h_1 \geq$	[mm]	27	27	32	27	43
Cutting diameter at the upper tolerance limit (max. diam. bit)	$d_{cut,max} \leq$	[mm]	8,45	10,45	10,45	12,50	12,50
Diameter of clearance hole in the fixture	$d_f \leq$	[mm]	7	9	9	12	12
Max installation torque moment	T_{inst}	[Nm]	4	8	8	15	15
Maximum screwing depth LA+/LAL+	L_{max}	[mm]	11	12	13	12	16
Minimum screwing depth	L_{min}	[mm]	6	8	8	10	10

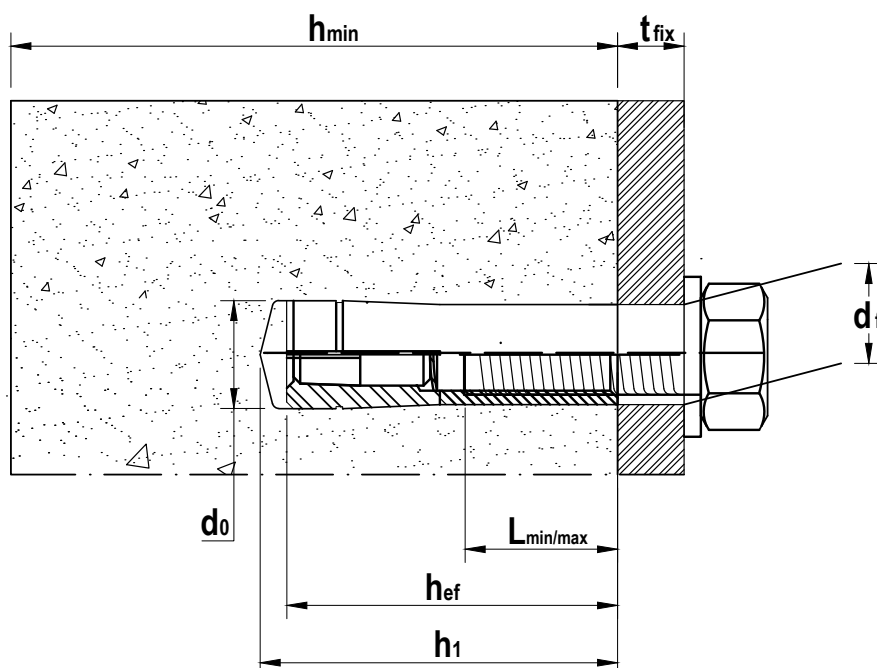
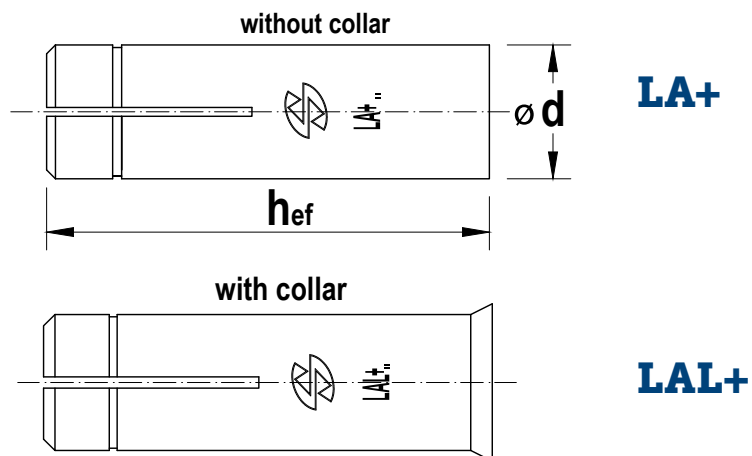

INSTALLATION

Setting tools

Anchor		M6 x 25	M8 x 25 / 30	M10 x 25	M10 x 40
Hardened carbon steel	Tool	LT+ 6	LT+ 8	LT+ 10x25	LT+ 10
		LT+ 6 PRO	LT+ 8 PRO	LT+ 10x25 PRO	LT+ 10 PRO
D1	[mm]	5	6,6	8,3	8,3
D2	[mm]	7,5	9,5	12	12
D3	[mm]	12	12	12	12
L1	[mm]	15	17,5	17	23,5
L2	[mm]	35	40	0	0
L3	[mm]	220	220	213	220

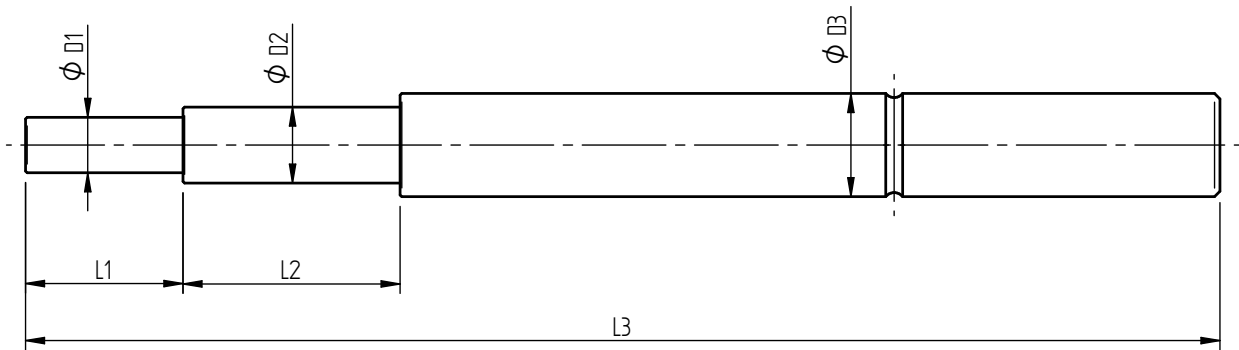

LT+ PRO



LT+



INSTALLATION

Minimum thickness of concrete member, spacing and edge distance

Cracked and non-cracked concrete			M6 x 25	M8 x 25	M8 x 30	M10 x 25	M10 x 40
Approval			ETA-13/0441	ETA-13/0441	ETA-13/0441	ETA-13/0441	ETA-13/0441
Anchorage depth	$h_{ef} = h_{nom}$	[mm]	25	25	30	25	40
Minimum thickness of base material	h_{min}	[mm]	100	100	100	100	100
Minimum spacing	s_{min}	[mm]	70	120	105	130	105
Minimum edge distance	c_{min}	[mm]	105	110	105	140	140
Characteristic spacing	s_{cr}	[mm]	80	220	120	220	240
Characteristic edge distance	c_{cr}	[mm]	40	110	60	110	120

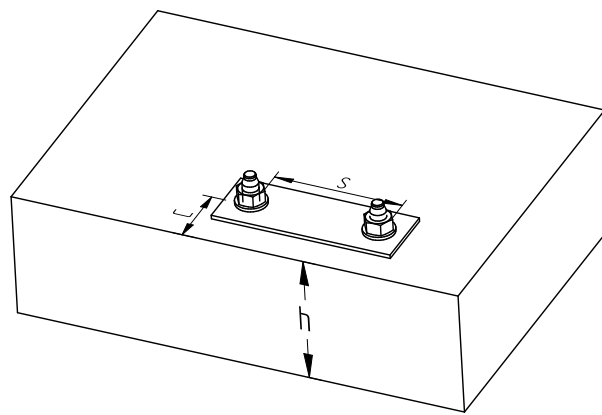

Minimum thickness, spacing and edge distance of precast prestressed hollow core slabs

Precast prestressed hollow core slabs flange thickness ≥ 35 mm			M8 x 25	M10 x 25
Approval			ETA-13/0441	ETA-13/0441
Anchorage depth	$h_{ef} = h_{nom}$	[mm]	25	25
Minimum thickness of base material	h_{min}	[mm]	200	200
Distance between plug position and prestressing steel	$a_p \geq$	[mm]	50	50
Minimum spacing	s_{min}	[mm]	180	180
Minimum edge distance	c_{min}	[mm]	150	150
Characteristic spacing	s_{cr}	[mm]	180	180
Characteristic edge distance	c_{cr}	[mm]	150	150

LA+ and LAL+ -intended use in precast prestressed hollow core slabs ($w/e \leq 4,2$) with flange thickness ≥ 35 mm and concrete C45/55 to C50/60

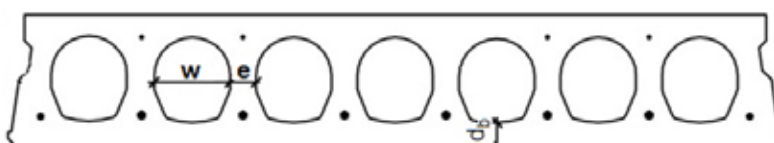
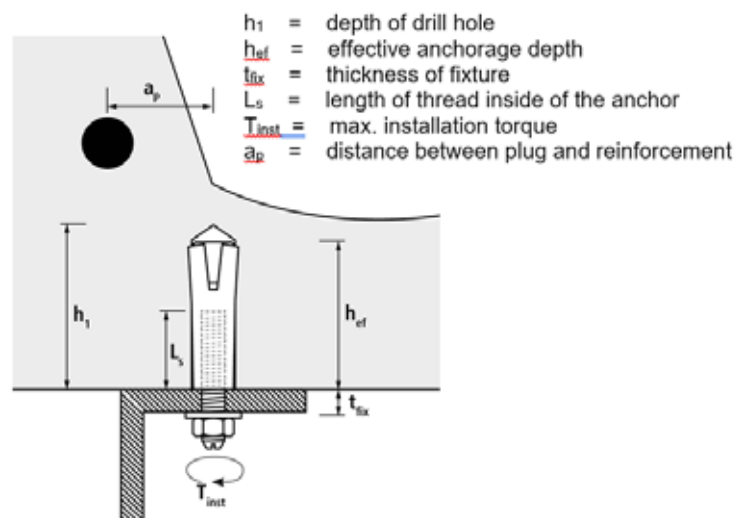

w = core width
 e = web thickness
 d_b = bottom flange thickness

Delivery program



Size	Length	Zinc	Zinc	Zinc
M6 x 25	25	LA+ 6 •	LAL+ 6 •	
M8 x 25	25			LAL+ 8x25 •
M8 x 30	30	LA+ 8 • ■	LAL+ 8 • ■	
M10 X 25	25			LAL+ 10x25 •
M10 x 40	40	LA+ 10 • ■	LAL+ 10 • ■	
M12 x 50	50	LA+ 12 ■	LAL+ 12 ■	
M16 x 65	65	LA+ 16 ■	LAL+ 16 ■	
M20 x 80	80	LA 20		

- ETA 13/0441 ■ ETA 13/0442

Values for M6-M20 single anchor use can be found from corresponding PDS document

LT+ PRO



LT+

